



Capacidad: Uso ligero a medio
Uso: Interiores y exteriores
Versiones: Montaje superior, en suelo y lateral
Aplicación: Balcones, galerías, pasarela, separadores, escaleras
Material: Aluminio (bruto y pulido anodizado)
Grosor del vidrio: De 12 a 21,52 mm

Proyecto inspiración:



q-railing.com/p-smart

EASY GLASS® SMART



reddot winner 2020
innovative product

Insuperable facilidad de instalación



Easy Glass® Smart funciona con el revolucionario Q-disc® System. La combinación del inserto y la herramienta especial Q-disc permite una instalación del vidrio extremadamente rápida. Instale el perfil para suelo, coloque el vidrio y, después, con un simple movimiento de mano, fije cada panel con seguridad en su lugar. Con la versión ajustable del Q-disc System podrá alinear cada panel de vidrio incluso verticalmente de manera individual. Una característica particular es el embellecedor Easy Glass que permite una conexión con continuidad con el suelo. El resultado es un acabado con estilo que incluye una protección extra del material. Utilice la goma intermedia correspondiente para la instalación de los embellecedores.

Easy Glass® Smart

Max. carga lineal (kN/m)

ES
1,6



Para las especificaciones técnicas de montaje, medidas del vidrio y tipos de vidrio, ver los respectivos certificados.



q-railing.com/certificates

Probado/Calculado/Certificado internacionalmente:



- 1 Con el sistema ajustable Q-disc System podrá alinear los paneles de vidrio individuales hasta a 0,6° desde la vertical.
- 2 El Q-disc le confirmará con un "click" que ha sido colocado correctamente.
- 3 Apto para vidrios de un grosor de 12 a 21,52 mm.

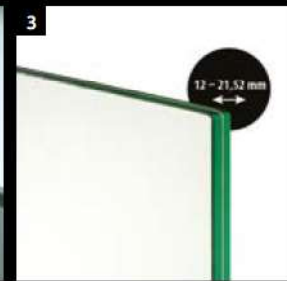
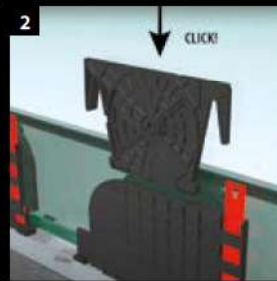

VERSIONES DE EASY GLASS® SMART

Smart

Montaje superior

- También para montaje en suelo

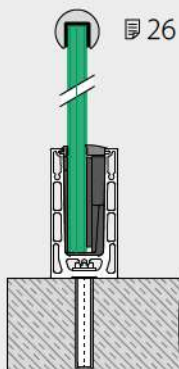

Smart F

Montaje superior

- Para suelos inacabados
- Se puede instalar en el borde de una superficie o más allá

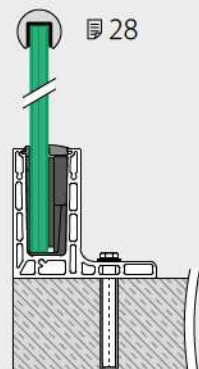

Smart

Montaje lateral

- También se puede montar en el lado interior de los muros de parapeto
- Revestimientos disponibles

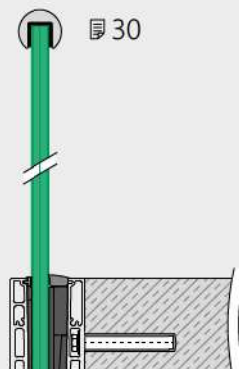

Smart Y

Montaje lateral

- Para suelos inacabados
- Se puede instalar en el borde de una superficie o más allá
- Revestimientos disponibles

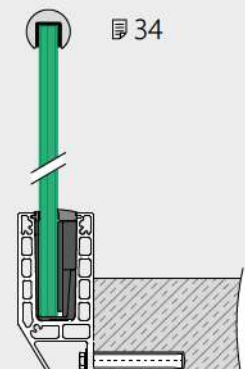



Q-DISC® SYSTEM AJUSTABLE

¡SOLO HAY QUE DESLIZAR PARA ALINEAR!



CÓMO FUNCIONA:

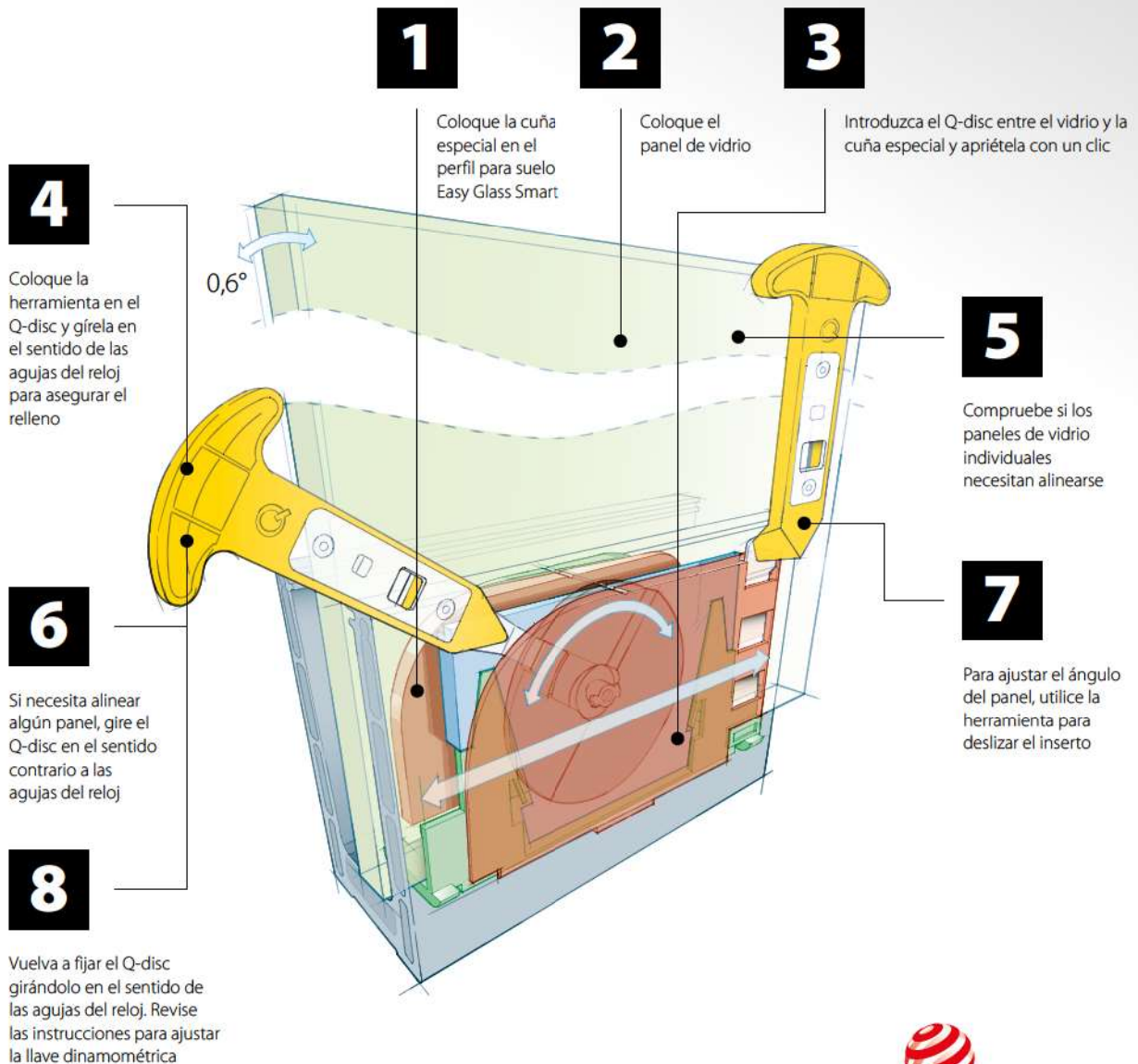

Q-disc® System (set de gomas, inserto y Q-disc®)

Para una fijación del vidrio ajustable



MOD 8201

Accesorios		
Monolíticos		
	T	
208201-050-12	12	L = 5000 mm
208201-050-15	15	L = 5000 mm
208201-250-12	12	L = 25 m
208201-250-15	15	L = 25 m
Laminados		
	T	
208201-050-13	12,76 (6-0,76-6)	L = 5000 mm
208201-050-14	13,52 (6-1,52-6)	L = 5000 mm
208201-050-17	16,76 (8-0,76-8)	L = 5000 mm
208201-050-18	17,52 (8-1,52-8)	L = 5000 mm
208201-250-13	12,76 (6-0,76-6)	L = 25 m
208201-250-14	13,52 (6-1,52-6)	L = 25 m
208201-250-17	16,76 (8-0,76-8)	L = 25 m
208201-250-18	17,52 (8-1,52-8)	L = 25 m



reddot winner 2020

International Design Model Protection

Herramienta Q-disc® y de inserto

Para una fijación del vidrio ajustable



MOD 1000

Accesorios		
	Q	
201000	Q-84	1

NEW

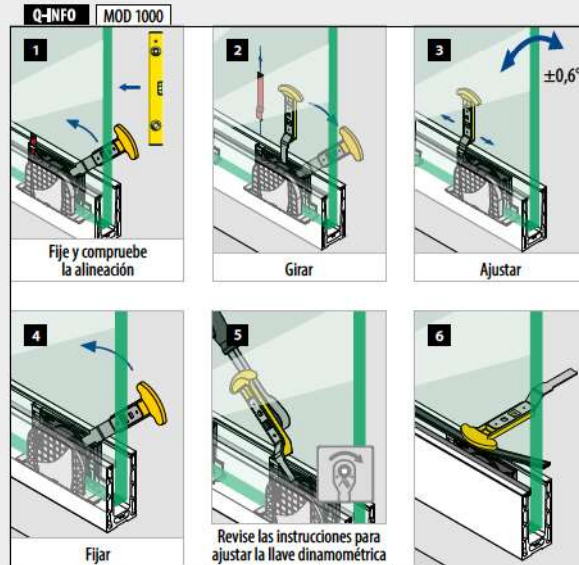

Q-disc® System (set de gomas, inserto y Q-disc®)

Para una fijación del vidrio



MOD 8200

Accesorios		
Monolíticos		
	T	
208200-050-12	12	L = 5000 mm
208200-050-15	15	L = 5000 mm
208200-050-19	19	L = 5000 mm
Laminados		
	T	
208200-050-13	12,76 (6-0,76-6) - 13,52 (6-1,52-6)	L = 5000 mm
208200-050-17	16,76 (8-0,76-8) - 17,52 (8-1,52-8)	L = 5000 mm
208200-050-21	20,76 (10-0,76-10) - 21,52 (10-1,52-10)	L = 5000 mm
208200-250-13	12,76 (6-0,76-6) - 13,52 (6-1,52-6)	L = 25 m
208200-250-17	16,76 (8-0,76-8) - 17,52 (8-1,52-8)	L = 25 m
208200-250-21	20,76 (10-0,76-10) - 21,52 (10-1,52-10)	L = 25 m

NEW
NEW
NEW

reddot winner 2020

International Design Model Protection

Herramienta Q-disc®

Para una fijación del vidrio



MOD 1009

Accesorios		
	Q	
201009	Q-83	1



Bases de barandillas

Perfiles para suelo, montaje superior

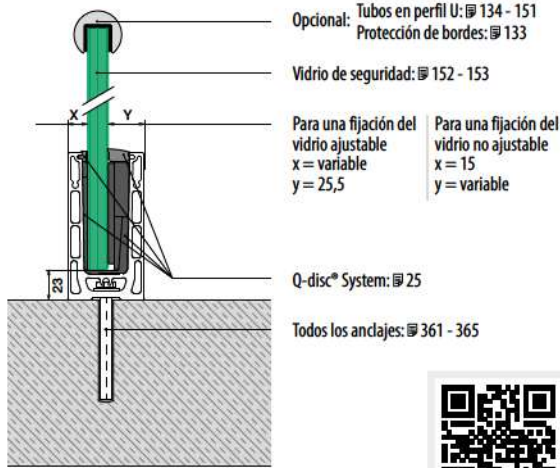

Para las especificaciones técnicas de montaje, medidas del vidrio y tipos de vidrio, ver los respectivos certificados.

Información sobre el montaje:
q-railing.com/qr-smart

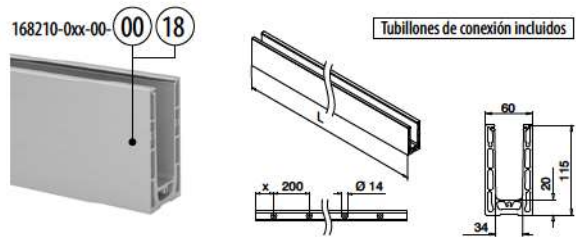

MOD 8210

Aluminio	Bruto		
	X		
168210-050-00-00	100	361 - 365	L = 5000 mm
Aluminio	Pulido, anodizado		
	OUTDOOR	X	
168210-025-00-18	50	361 - 365	L = 2500 mm
168210-050-00-18	100	361 - 365	L = 5000 mm



International Design
Model Protection

Bases de barandillas

Esquinas, montaje superior

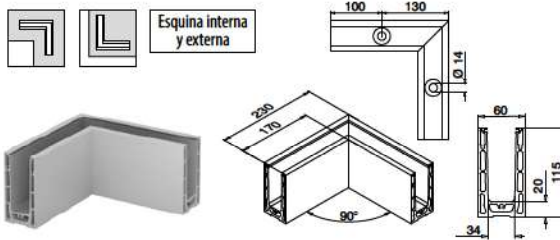

MOD 8211

Aluminio	Bruto		
	X		
168211-00-00	100	361 - 365	1
Aluminio	Pulido, anodizado		
	OUTDOOR	X	
168211-00-18	100	361 - 365	1



International Design Model Protection

Q-INFO MOD 8210

Perfiles de cierre: 38 - 39

MOD 8205 381

Goma para perfiles de cierre / intermedio

Video de instalación:
q-railing.com/qr-trims

Q-INFO MOD 8210

PREFIX

Q-INFO

MOD 3005 382

Tubillones de conexión adicionales

Q-INFO Aluminio

00 Bruto

18 Pulido, anodizado

Tapetas terminales, montaje superior

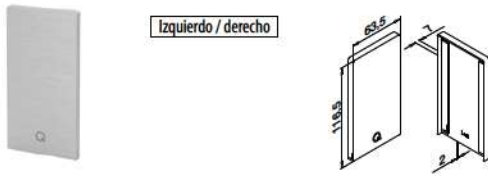

MOD 8212

Aluminio		Bruto	
Aluminio		Cinta adhesiva 3M	
168212-00-00	Incluida en embalaje		1
Aluminio		Pulido, anodizado	
OUTDOOR		Cinta adhesiva 3M	
168212-00-18	Prefijada		1

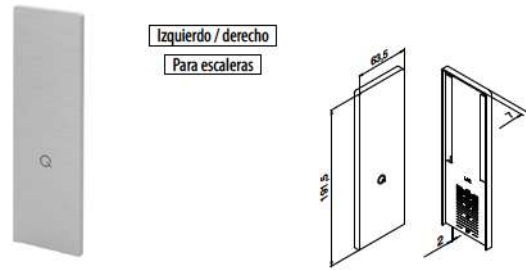

MOD 8213

Aluminio		Bruto	
Aluminio		Cinta adhesiva 3M	
168213-00-00	Incluida en embalaje		1
Aluminio		Pulido, anodizado	
OUTDOOR		Cinta adhesiva 3M	
168213-00-18	Prefijada		1



Calza, montaje superior

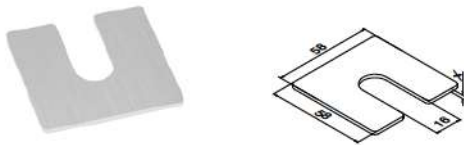

MOD 8216

Aluminio		Bruto	
Aluminio		X	
168216-001	1		100
168216-002	2		100
168216-003	3		100

Perfiles de drenaje, montaje superior

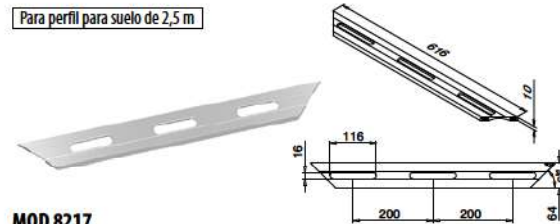

MOD 8217

Aluminio		Pulido, anodizado	
OUTDOOR			
168217-18			4



Q-INFO MOD 8212

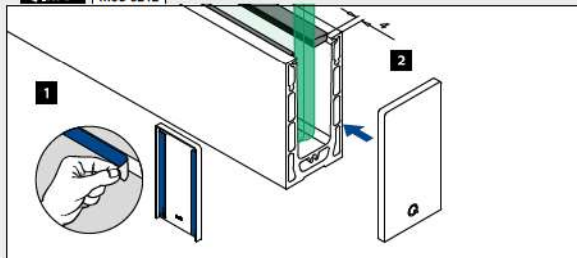

Q-INFO MOD 8216

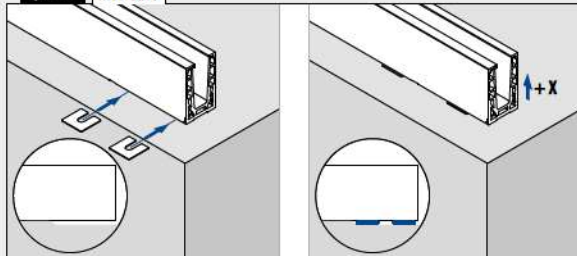

Q-INFO MOD 8213

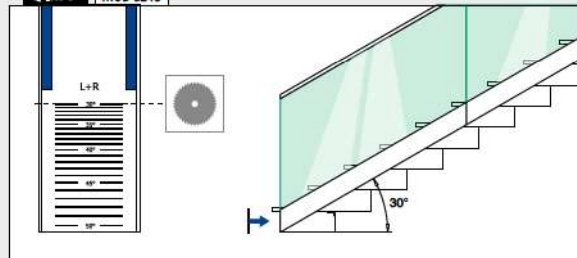

Q-INFO MOD 8217



Información sobre el montaje:



q-railling.com/
al-8217

Bases de barandillas

Perfiles para suelo, montaje superior

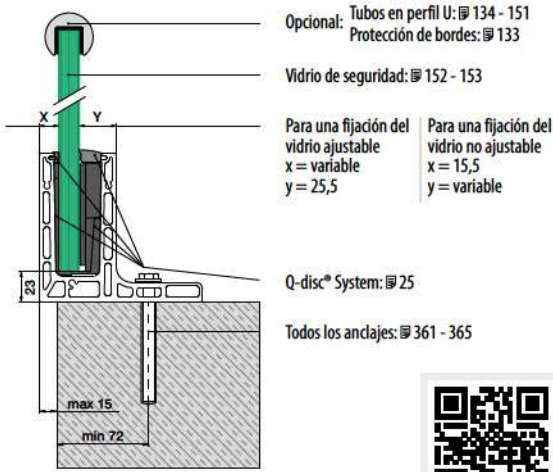

Para las especificaciones técnicas de montaje, medidas del vidrio y tipos de vidrio, ver los respectivos certificados.

Información sobre el montaje:
q-railing.com/qr-smart

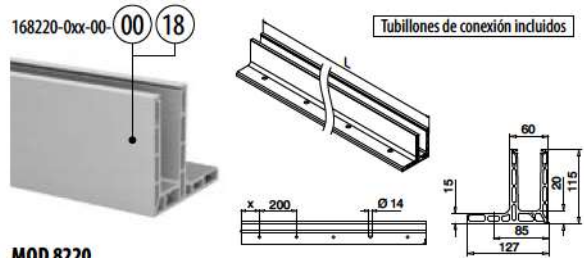

MOD 8220

Aluminio	Bruto	X		
168220-050-00-00	100	361 - 365	L = 5000 mm	

Aluminio	Pulido, anodizado	X		
OUTDOOR	50	361 - 365	L = 2500 mm	
168220-050-00-18	100	361 - 365	L = 5000 mm	



International Design Model Protection

Bases de barandillas

Esquinas, montaje superior

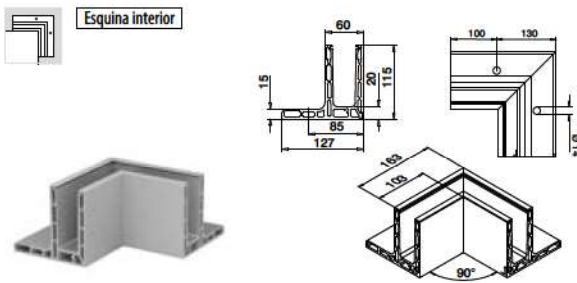

MOD 8221

Aluminio	Pulido, anodizado			
OUTDOOR				
168221-01-18	361 - 365	1		



International Design Model Protection

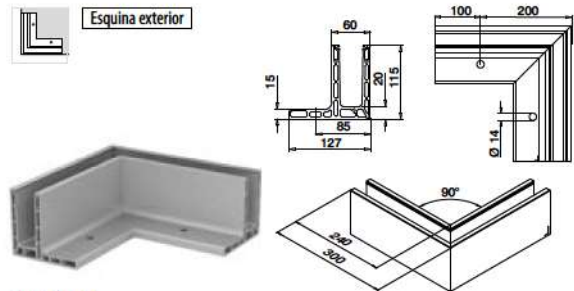

MOD 8221

Aluminio	Pulido, anodizado			
OUTDOOR				
168221-02-18	361 - 365	1		



International Design Model Protection

Q-INFO

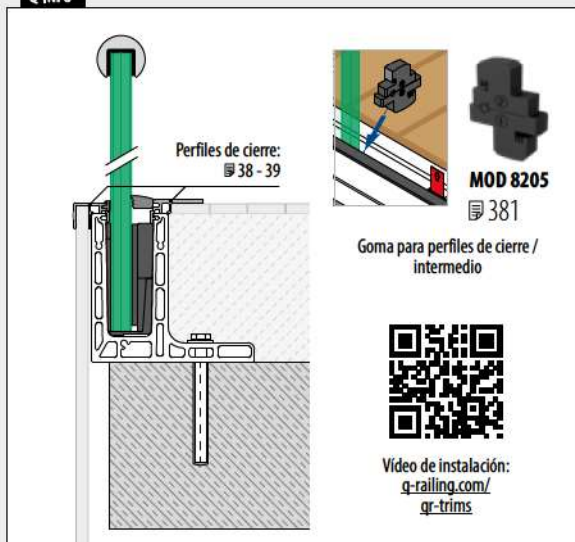

Q-INFO MOD 8220

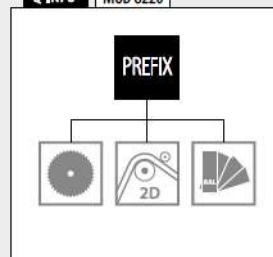

Q-INFO



Q-INFO Aluminio



Tapetas terminales, montaje superior

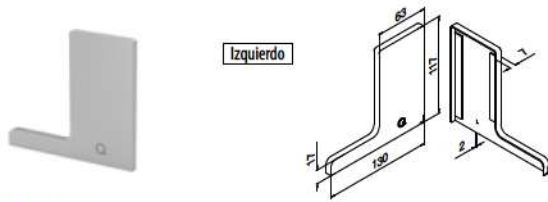

MOD 8222

Aluminio	Bruto		
	Cinta adhesiva 3M		
168222-01-00	Incluida en embalaje	1	
Aluminio	Pulido, anodizado		
OUTDOOR	Cinta adhesiva 3M		
168222-01-18	Prefijada	1	

NEW

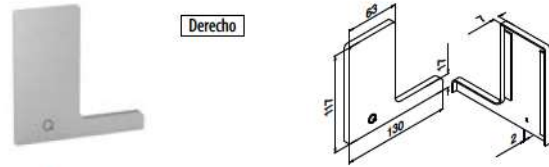

MOD 8222

Aluminio	Bruto		
	Cinta adhesiva 3M		
168222-02-00	Incluida en embalaje	1	
Aluminio	Pulido, anodizado		
OUTDOOR	Cinta adhesiva 3M		
168222-02-18	Prefijada	1	

NEW

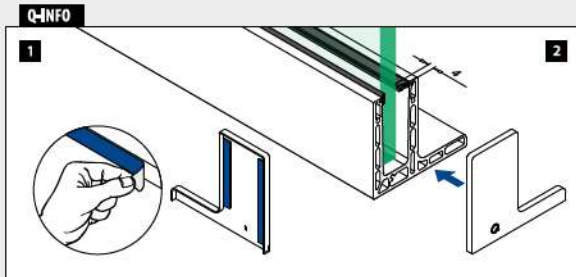

Bases de barandillas

Perfiles para suelo, montaje lateral

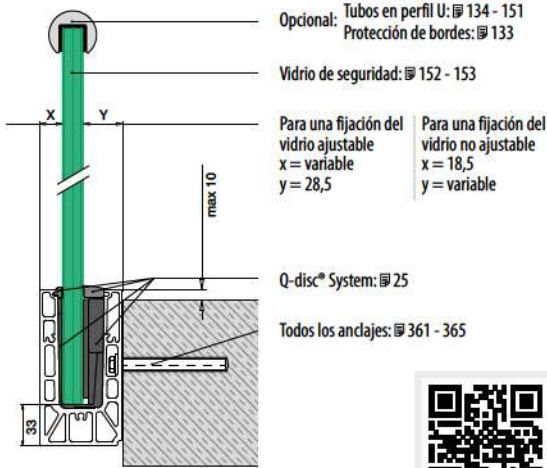

Opcional: Tubos en perfil U: 134 - 151
Protección de bordes: 133

Vidrio de seguridad: 152 - 153

Para una fijación del vidrio ajustable
x = variable
y = 28,5

Para una fijación del vidrio no ajustable
x = 18,5
y = variable

Q-disc® System: 25

Todos los anclajes: 361 - 365



Para las especificaciones técnicas de montaje, medidas del vidrio y tipos de vidrio, ver los respectivos certificados.

Información sobre el montaje:
q-railing.com/qr-smart

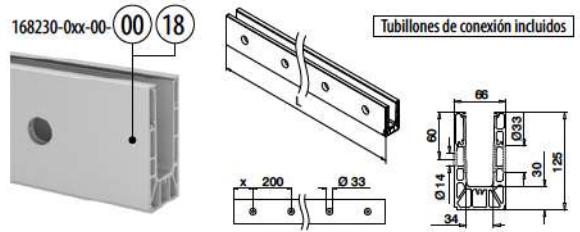

MOD 8230

Aluminio	Bruto	X		
168230-050-00-00	100	361 - 365	L = 5000 mm	

Aluminio	Pulido, anodizado	X		
OUTDOOR	168230-025-00-18	50	361 - 365	L = 2500 mm
	168230-050-00-18	100	361 - 365	L = 5000 mm



International Design
Model Protection

Bases de barandillas

Esquinas, montaje lateral

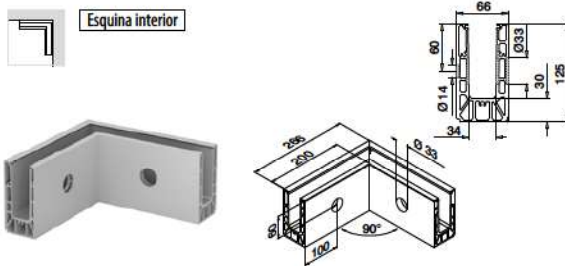

MOD 8231

Aluminio	Bruto		
168231-01-00	361 - 365	1	
Aluminio	Pulido, anodizado		
OUTDOOR	168231-01-18	361 - 365	1



International Design Model Protection

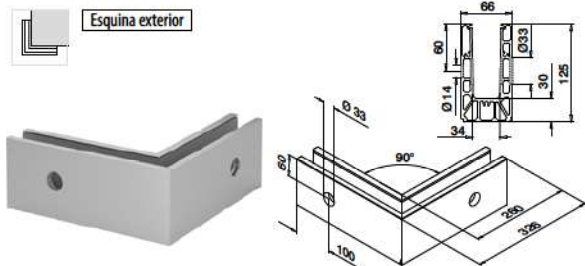

MOD 8231

Aluminio	Bruto		
168231-02-00	361 - 365	1	
Aluminio	Pulido, anodizado		
OUTDOOR	168231-02-18	361 - 365	1



International Design Model Protection

Q-INFO

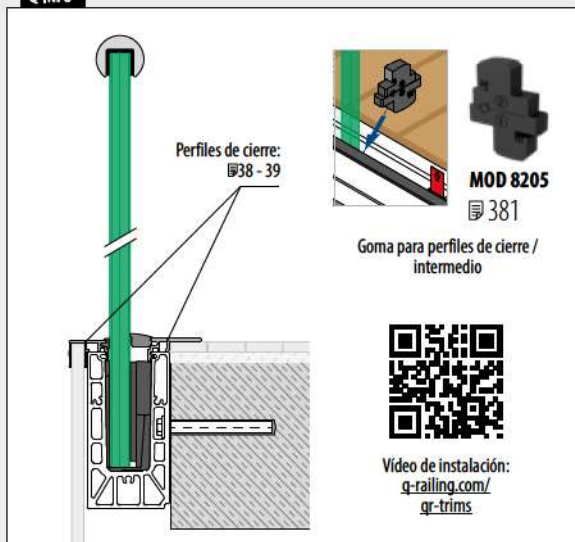

Perfiles de cierre:
38 - 39

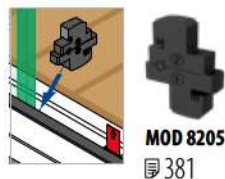

Goma para perfiles de cierre / intermedio



Video de instalación:
q-railing.com/qr-trims

Q-INFO MOD 8230

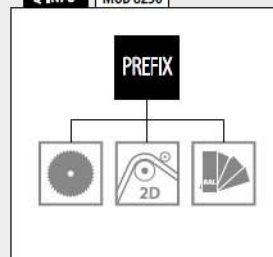

Q-INFO



Tubillones de conexión adicionales

Q-INFO Aluminio



Tapetas terminales, montaje lateral



MOD 8232

Aluminio	Bruto		
	Cinta adhesiva 3M		
168232-01-00	Incluida en embalaje	1	
Aluminio	Pulido, anodizado		
OUTDOOR	Cinta adhesiva 3M		
168232-01-18	Prefijada	1	



MOD 8232

Aluminio	Bruto		
	Cinta adhesiva 3M		
168232-02-00	Incluida en embalaje	1	
Aluminio	Pulido, anodizado		
OUTDOOR	Cinta adhesiva 3M		
168232-02-18	Prefijada	1	

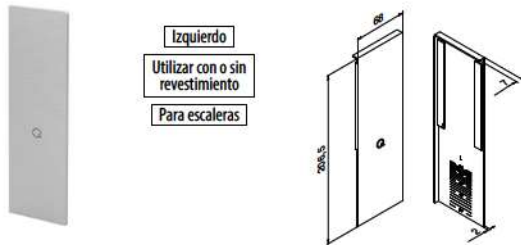

MOD 8233

Aluminio	Bruto		
	Cinta adhesiva 3M		
168233-01-00	Incluida en embalaje	1	
Aluminio	Pulido, anodizado		
OUTDOOR	Cinta adhesiva 3M		
168233-01-18	Prefijada	1	

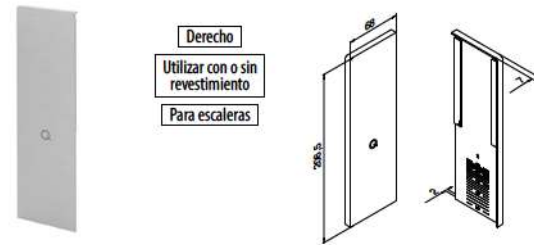

MOD 8233

Aluminio	Bruto		
	Cinta adhesiva 3M		
168233-02-00	Incluida en embalaje	1	
Aluminio	Pulido, anodizado		
OUTDOOR	Cinta adhesiva 3M		
168233-02-18	Prefijada	1	

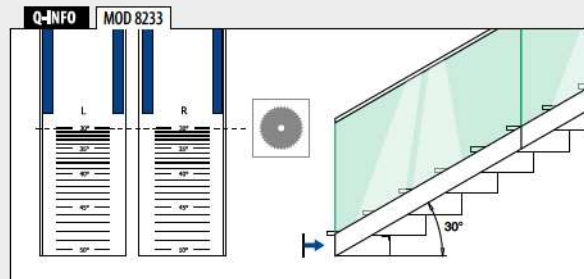
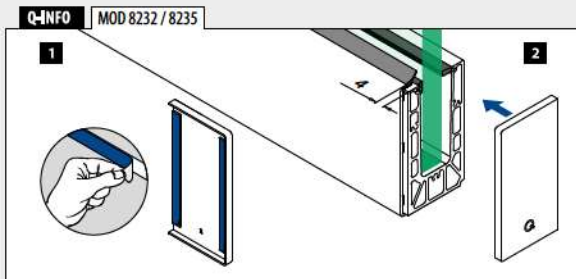

Bases de barandillas

Perfiles de drenaje, montaje lateral

Para perfil para suelo de 2,5 m

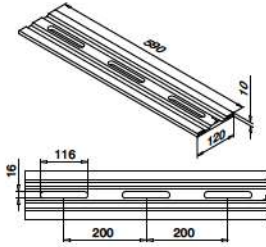

MOD 8237

Aluminio	Pulido, anodizado	
OUTDOOR		
168237-18		4

NEW

Bases de barandillas

Calza, montaje lateral

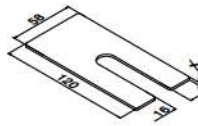

MOD 8236

Aluminio	Bruto		
		X	
168236-001		1	100
168236-002		2	100
168236-003		3	100

NEW

Q-INFO MOD 8237

Información sobre el montaje:

q-railing.com/al-8237

Q-INFO MOD 8236

+ X

Q-INFO **Aluminio** MOD 8237 / 8234 / 8235

00 Bruto

18 Pulido, anodizado

Revestimiento, montaje lateral



MOD 8235

Aluminio	Bruto	Cinta adhesiva 3M	
168235-050-00	No incluida*	L = 5000 mm	
Aluminio	Pulido, anodizado		
OUTDOOR	Cinta adhesiva 3M		
168235-050-18	Prefijada	L = 5000 mm	



*Pida MOD 1360 (Cinta adhesiva 3M)

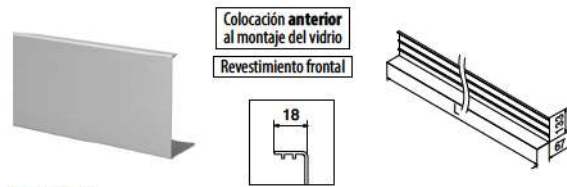

MOD 8234

Aluminio	Bruto	Cinta adhesiva 3M	
168234-050-00	No incluida*	L = 5000 mm	
Aluminio	Pulido, anodizado		
OUTDOOR	Cinta adhesiva 3M		
168234-050-18	Prefijada	L = 5000 mm	



*Pida MOD 1360 (Cinta adhesiva 3M)

Tapones ciegos, montaje lateral

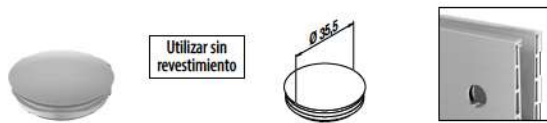

MOD 8238

ABS plástico	Bianco aluminio RAL 9006		
OUTDOOR			
158238-36	10		

Cinta adhesiva acrílica 3M



MOD 1360

Accesorios	Q	W	L	
201360	Q-53	9	33 m (11 m para cada revestimiento)	1



Q-INFO MOD 8235-050-00 / 1360

Información sobre el montaje:



Solo hasta fin de existencias.

Q-INFO MOD 8234

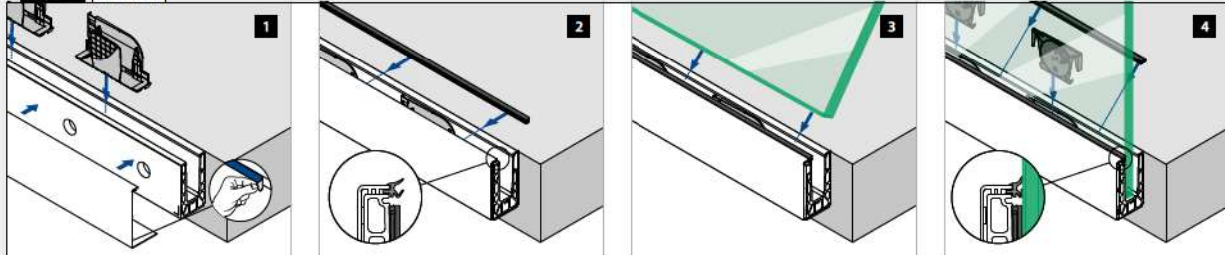

Q-INFO MOD 8235

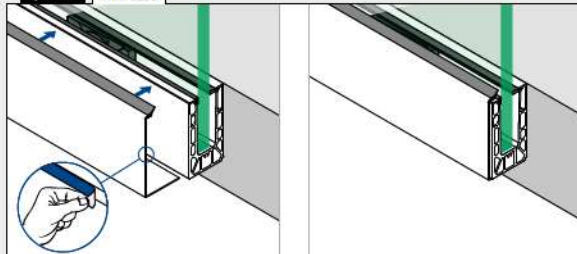

Q-INFO MOD 8238

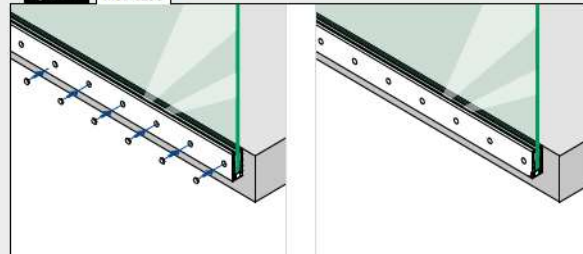

Bases de barandillas

Perfiles para suelo, montaje lateral

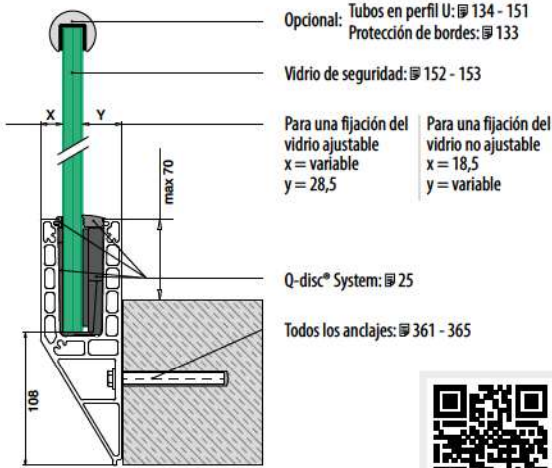

Opcional: Tubos en perfil U: 134 - 151
Protección de bordes: 133

Vidrio de seguridad: 152 - 153

Para una fijación del vidrio ajustable
x = variable
y = 28,5

Para una fijación del vidrio no ajustable
x = 18,5
y = variable

Q-disc® System: 25

Todos los anclajes: 361 - 365



Para las especificaciones técnicas de montaje, medidas del vidrio y tipos de vidrio, ver los respectivos certificados.

Información sobre el montaje:
q-railing.com/qr-smart

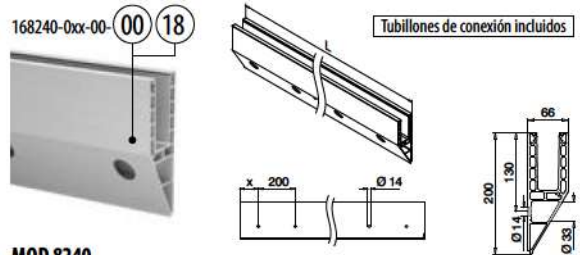

MOD 8240

Aluminio	Bruto	X		
168240-050-00-00	100	361 - 365	L = 5000 mm	

Aluminio	Pulido, anodizado	X		
OUTDOOR				
168240-025-00-18	50	361 - 365	L = 2500 mm	
168240-050-00-18	100	361 - 365	L = 5000 mm	



International Design
Model Protection

Bases de barandillas

Esquinas, montaje lateral

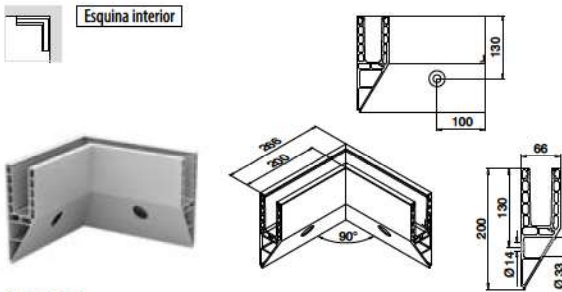

MOD 8241

Aluminio	Pulido, anodizado			
OUTDOOR				
168241-01-18	361 - 365	1		



International Design Model Protection

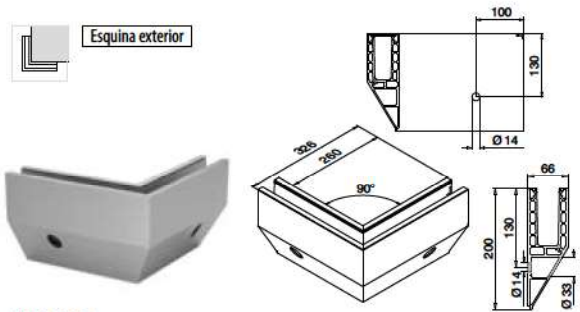

MOD 8241

Aluminio	Pulido, anodizado			
OUTDOOR				
168241-02-18	361 - 365	1		



International Design Model Protection

Q-INFO

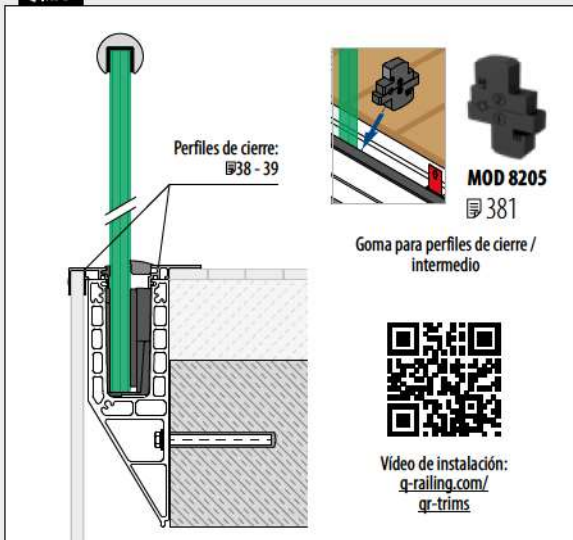

Perfiles de cierre:
38 - 39

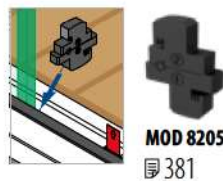

Goma para perfiles de cierre / intermedio



Video de instalación:
q-railing.com/qr-trims

Q-INFO

MOD 8240

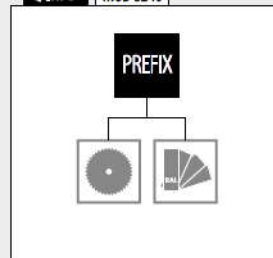

Q-INFO



Tubillones de conexión adicionales

Q-INFO

Aluminio

MOD 8240



Bruto

Pulido, anodizado

Tapetas terminales, montaje lateral



Izquierdo
Utilizar sin revestimiento



MOD 8242

Aluminio	Bruto	
	Cinta adhesiva 3M	
168242-01-00	Incluida en embalaje	1
Aluminio	Pulido, anodizado	
OUTDOOR	Cinta adhesiva 3M	
168242-01-18	Prefijada	1

NEW



Derecho
Utilizar sin revestimiento

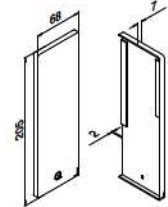

MOD 8242

Aluminio	Bruto	
	Cinta adhesiva 3M	
168242-02-00	Incluida en embalaje	1
Aluminio	Pulido, anodizado	
OUTDOOR	Cinta adhesiva 3M	
168242-02-18	Prefijada	1

NEW



Izquierdo
Utilizar con o sin revestimiento
Para escaleras

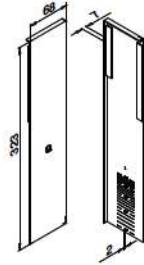

MOD 8243

Aluminio	Pulido, anodizado	
OUTDOOR	Cinta adhesiva 3M	
168243-01-18	Prefijada	1

NEW



Derecho
Utilizar con o sin revestimiento
Para escaleras

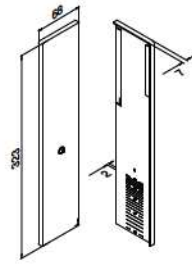

MOD 8243

Aluminio	Pulido, anodizado	
OUTDOOR	Cinta adhesiva 3M	
168243-02-18	Prefijada	1

NEW

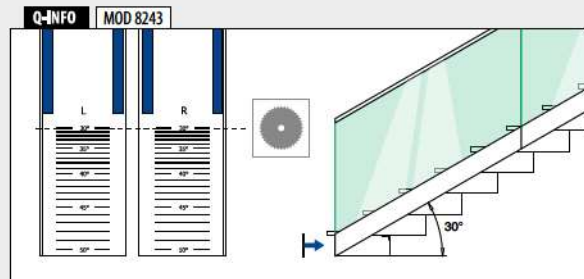
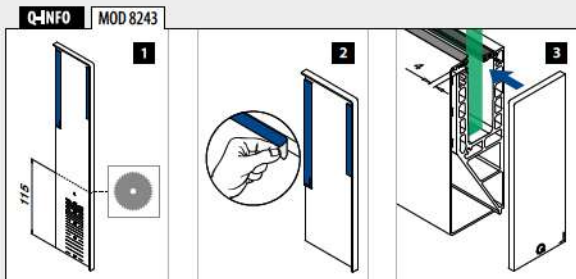

Bases de barandillas

Revestimiento, montaje lateral



MOD 8245

Aluminio	Bruto		
		Cinta adhesiva 3M	
168245-050-00	No incluida*	L = 5000 mm	
Aluminio	Pulido, anodizado		
OUTDOOR		Cinta adhesiva 3M	
168245-050-18	Prefijada	L = 5000 mm	



*Pida MOD 1360 (Cinta adhesiva 3M)

Accesorios

Cinta adhesiva acrílica 3M



MOD 1360

	Accesorios			
	Q	W	L	
201360	Q-53	9	33 m (11 m para cada revestimiento)	1



Q-INFO **Aluminio** MOD 8245



Q-INFO MOD 8245-050-00 / 1360



Q-INFO MOD 8245

